

viewmate^x

Warranty

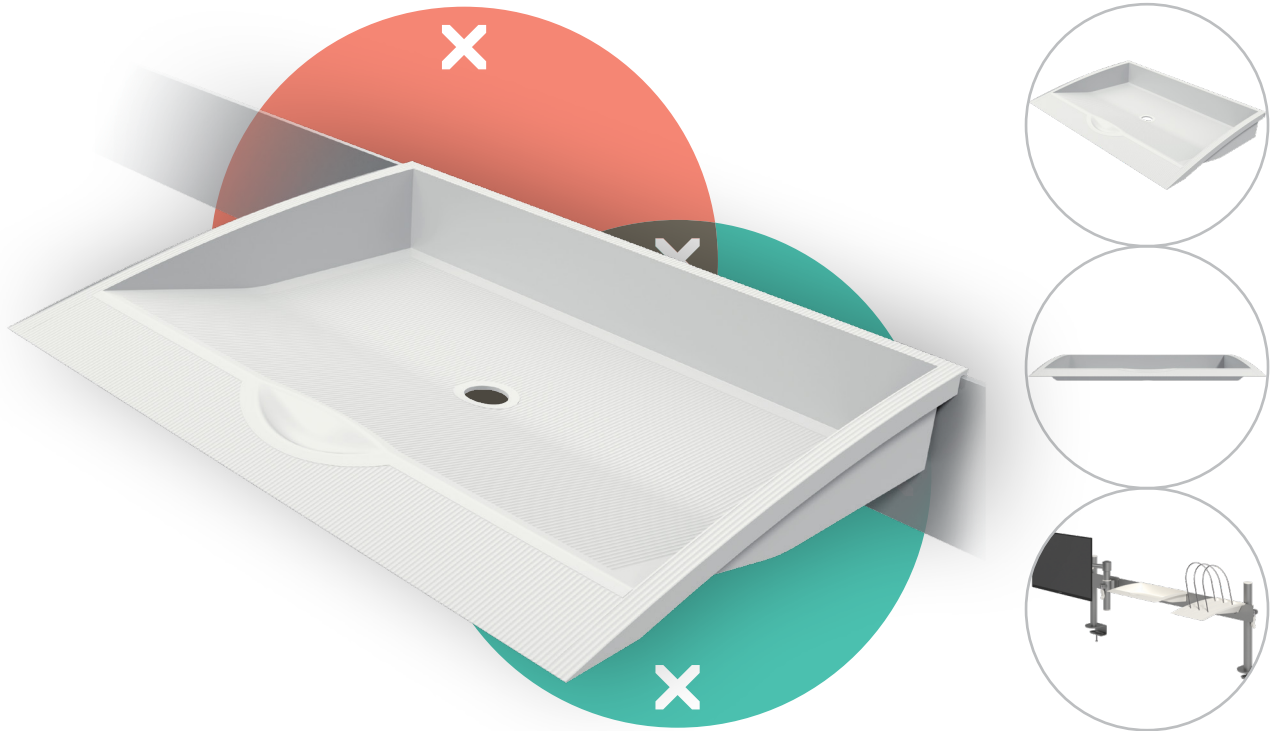

52.190

Viewmate A4 tray - option 190

Holds anything up to an A4 size. The accessory simply hooks onto the toolbar, making it easy to install or remove.

- Holds anything up to an A4 size

- Dimensions (w x d x h): 335 x 251x 52 mm (13,2 x 9,9 x 2,0")

dataflex

feeling at work

viewmate

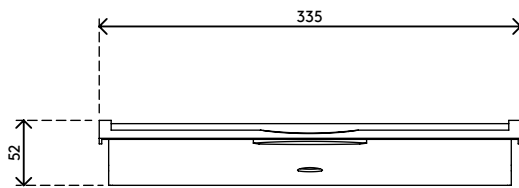
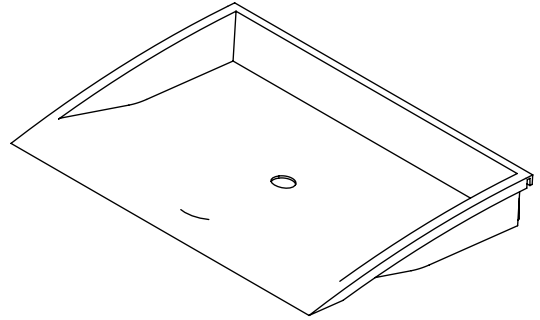
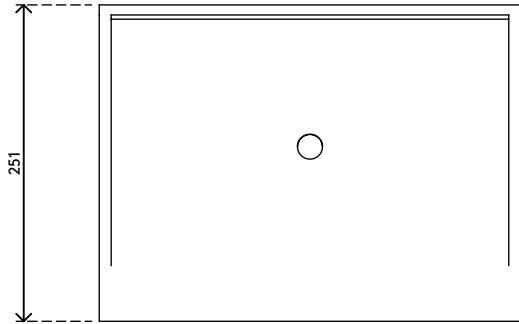

Viewmate A4 tray - option 190

2020/10/06

52.190

 345 x 255 x 60 mm

 1 pcs

 white

 0,49 kg

 805410521905