

viewlite

FIRA
Part of the Exova Group

Warranty

15
years

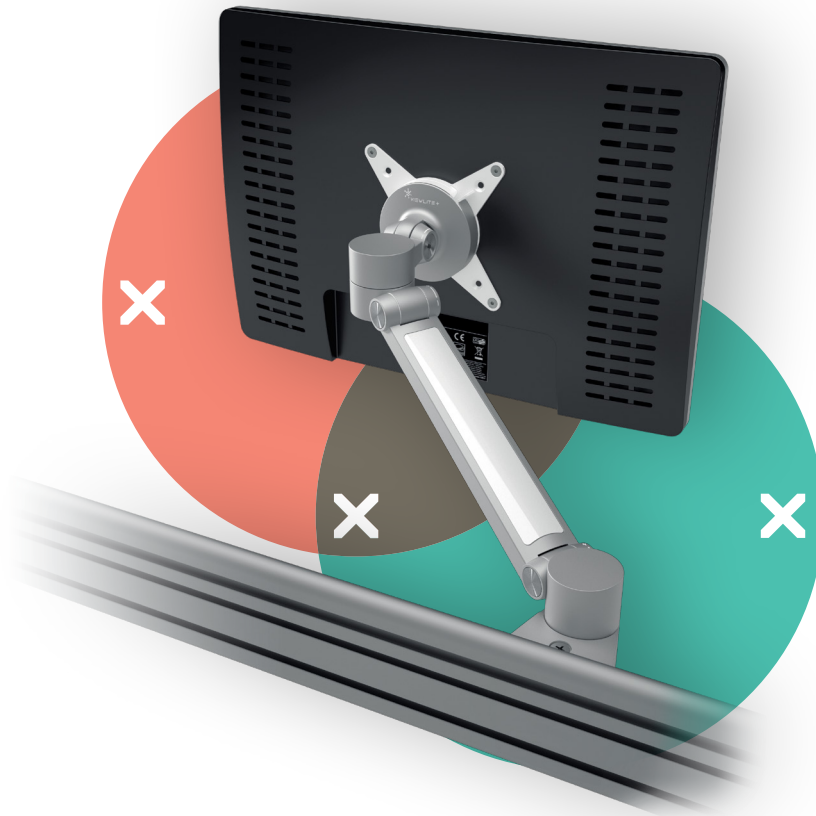

58.512

Viewlite plus monitor arm - rail 512

Free up desk space with this monitor arm that mounts onto a slat rail/wall or toolbar. It's easy to use and with the swivel limiter, which reduces the chance of bumping into walls or desks, you can locate it pretty well anywhere. Cables are easily hidden in the arm's aluminium extension to create a tidy, professional impression.

- Dynamic height adjustment range of 240 mm (9,4")
- Dependent depth adjustment
- Integrated cable management
- Main components made of aluminium
- 40% of aluminium content is already recycled
- VESA MIS-D 75 x 75/100 x 100 mm compatible
- Monitor: tilt +90°/-55°, swivel +90°/-90°, rotate 360°
- Arm: swivel +90°/-90°
- Weight capacity min. 0 kg - max. 7 kg (0 - 15,4 lb) per monitor
- Comes with a rail mount
- Fitted with a practical quick-release VESA system
- Monitor rotation lock can be enabled
- Swivel limiter pre-set to +90°/-90° or can be disabled

dataflex

feeling at work

viewlite

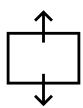
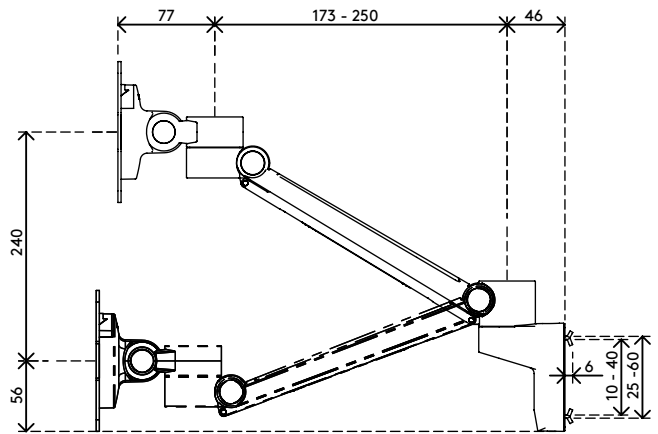
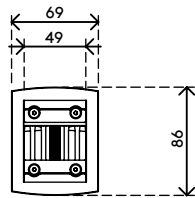
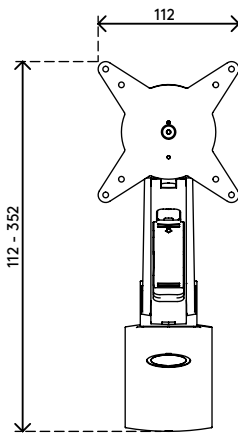
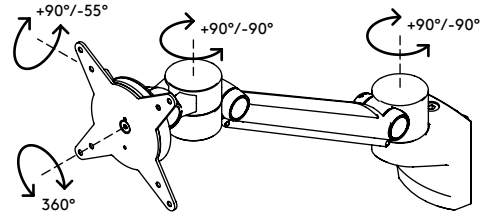
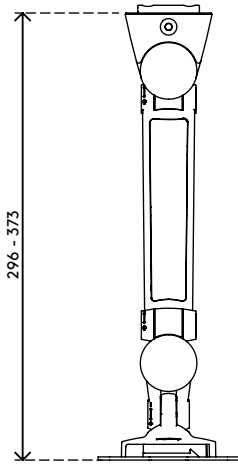

240 mm (9,4")



+90°/-55°

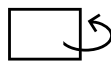

+90°/-90°



360°



75 x 75/100 x 100



0 - 7 kg (0 -15,4 lb)

Viewlite plus monitor arm - rail 512

2020/10/06

58.512

 477 x 153 x 145 mm

 1 pcs

 silver-white

 2,151 kg

 805410585129