

viewmaster^x

Garantie



53.323

Viewmaster système multi-écrans - bureau 32

Ce modèle permet d'installer un total de 4 écrans. Comme sur tous les autres systèmes multi-écrans à double-bras, chaque écran peut être réglé individuellement. La gestion de câbles dans les double-bras permet d'obtenir un poste de surveillance incurvé aux dimensions impressionnantes.

- Réglage direct de la hauteur
- Pour 4 écrans
- Clips câbles et colliers fournis
- Pièces en aluminium moulé sous pression
- Compatible VESA MIS-D 75 x 75/100 x 100 mm
- Écran: s'incline à +55°/-55°, pivote à +90°/-90°, tourne à 360°
- Poids supporté : max. 12 kg par écran
- Fixation pour bureau non fournie
- Limites dimensionnelles de l'écran : largeur 555 mm - hauteur 428 mm
- En raison de son excellente stabilité, convient également aux écrans tactiles

dataflex

feeling at work

viewmaster

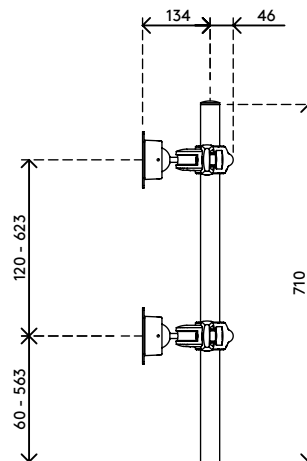
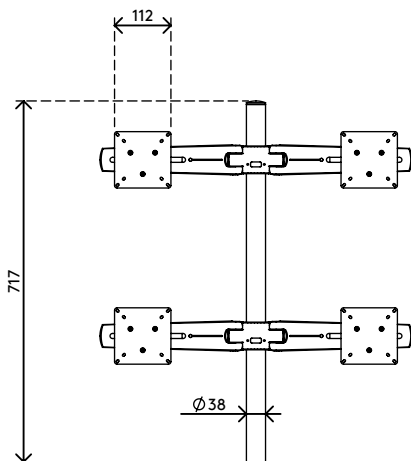
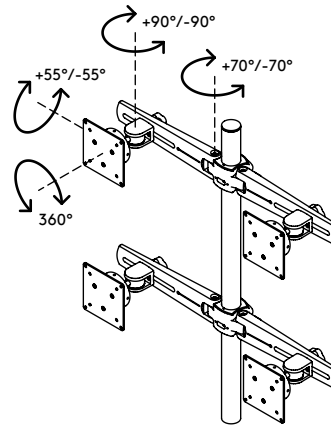
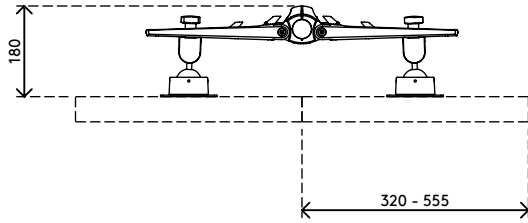

+55°/-55°

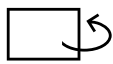

+90°/-90°



360°



555 mm (21,8")



428 mm (16,9")



75 x 75/100 x 100



(4x) 12 kg

Viewmaster système multi-écrans - bureau 32

2020/05/28

53.323

 740 x 395 x 120 mm

 1 pcs

 noir

 7,74 kg

 805410533236