

viewmaster^x

Garanzia

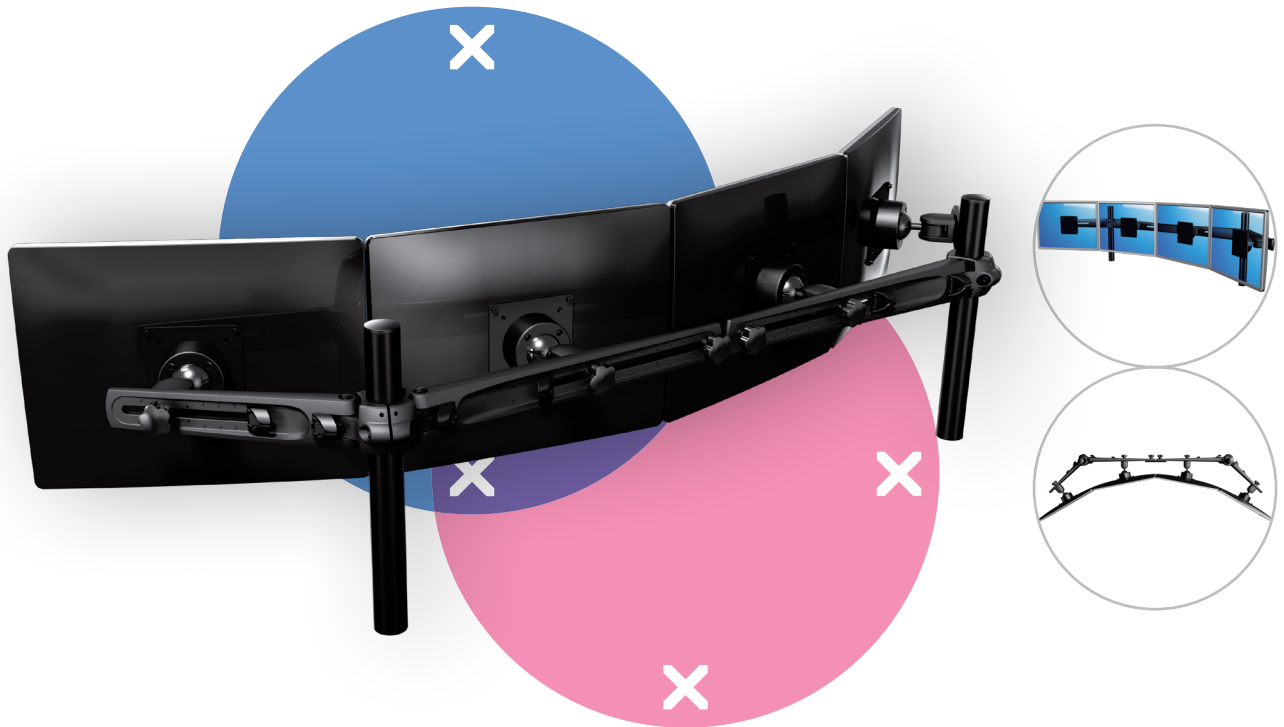

53.433

Viewmaster sistema multi-monitor - scrivania 433

Questo modello consente il fissaggio di 4 monitor in fila. Come in tutti gli altri sistemi multi-monitor ad ala, ciascun monitor può essere regolato individualmente. La gestione dei cavi nelle ali consente di tenere ordinati tutti i cavi e di ottenere una postazione incurvata e di grande impatto.

- Regolazione graduale dell'altezza
- Per 4 monitor
- Clip per cavi e fascette ferma cavi comprese
- Parti in alluminio pressofuso
- Compatibile con VESA MIS-D 75 x 75/100 x 100 mm
- Monitor: inclinazione +55°/-55°, orientabile +90°/-90°, rotazione 360°
- Capacità peso max. di 12 kg per monitor
- Fissaggi per scrivania non inclusi
- Dimensioni massime monitor: larghezza 500 mm - altezza 428 mm
- Grazie all'eccellente stabilità è adatto anche per i touchscreen

dataflex

feeling at work

viewmaster x

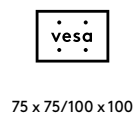
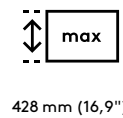
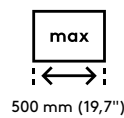
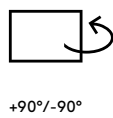
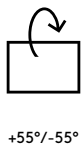
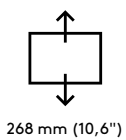
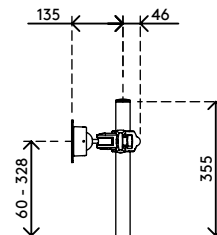
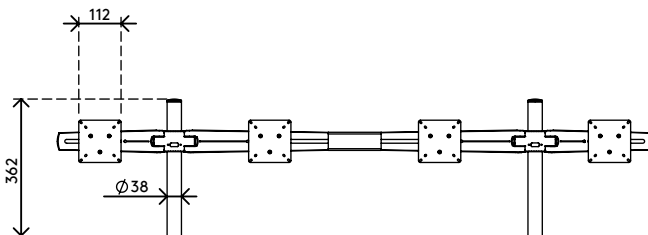
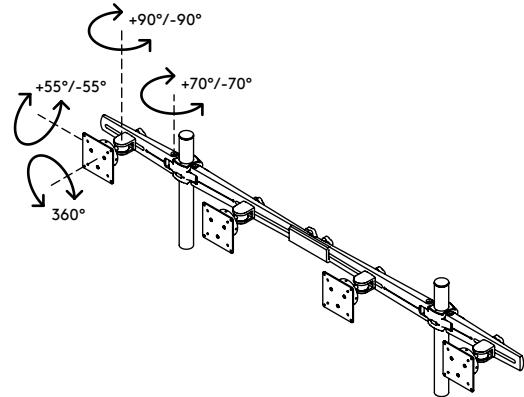
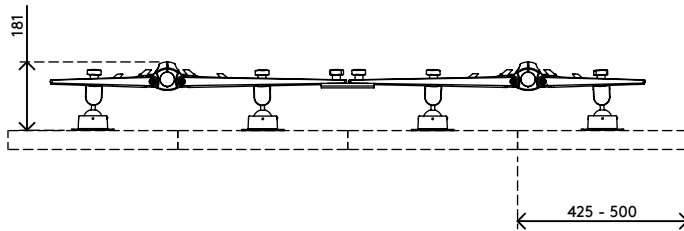

Viewmaster sistema multi-monitor - scrivania 433

2020/10/07

53.433

740 x 395 x 122 mm

1 pcs

nero

10,3 kg

805410534332