

96.513

Addit voetensteun - verstelbaar 513

Voetensteunen ondersteunen uw benen en helpen daarmee indirect de lage rugspieren, zodat u met minder moeite rechtop kunt zitten. Deze praktische voetensteun is verstelbaar in hoogte en hellingshoek en heeft vier verschillende instellingen.

- Fraai ontwerp
- Hoogte en hoek instelbaar op 4 verschillende standen
- In hoogte verstelbaar 79 - 111 mm

- Afmetingen (b x d x h): 450 x 348 - 371 x 79 - 111 mm
- Hoekaanpassing in 4 stappen: 7°, 10°, 14° and 17°

addit

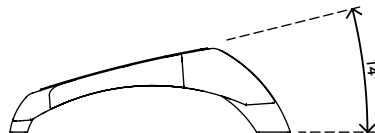
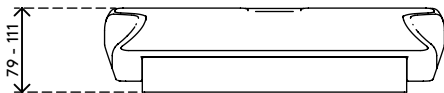
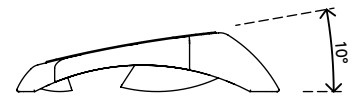
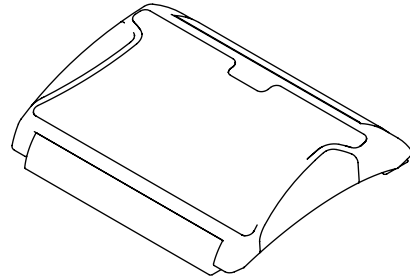
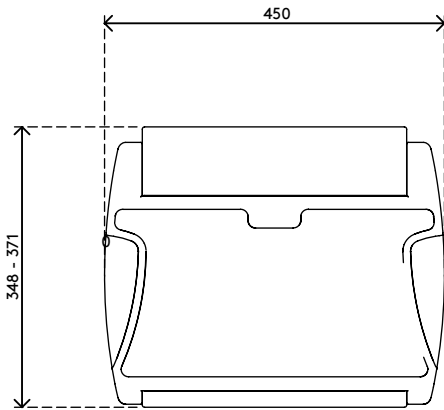

Addit voetensteun - verstelbaar 513

2021/03/11

96.513

 405 x 350 x 90 mm

 1 pcs

 zwart

 1,66 kg

 805410965136