

33.782

Addit bobina mangiacavo $\varnothing 25$ mm/3 m & utensile inseritore 782

Un'ottima soluzione per ordinare i cavi di alimentazione e segnale. È sufficiente raggruppare manualmente i cavi, usare l'utensile inseritore della bobina mangiacavo e inserire i cavi attraverso la bobina. Dotata di 1 utensile inseritore.

- Consente di risparmiare tempo e fatica
- Facile da installare con l'apposito utensile inseritore incluso
- Bobina mangiacavo con utensile inseritore, in un unico imballaggio
- Dimensioni (\varnothing x l): 25 mm x 3 m
- Adatto per 6 cavi con 7 mm di spessore

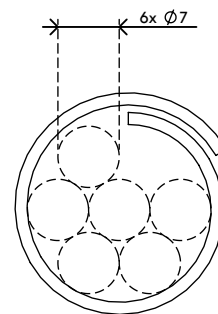
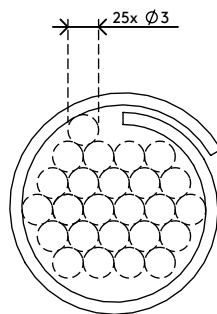
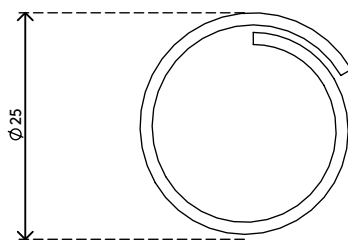
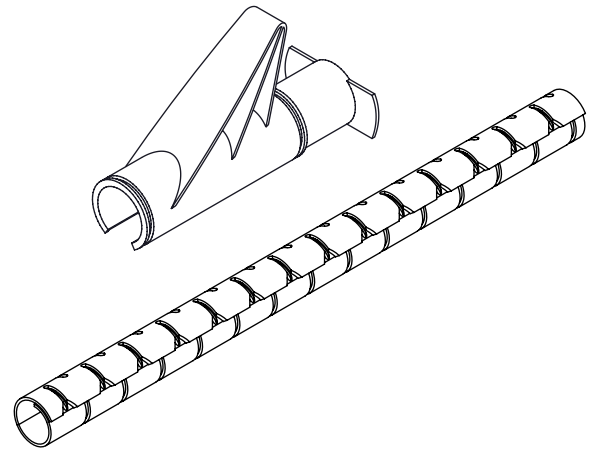
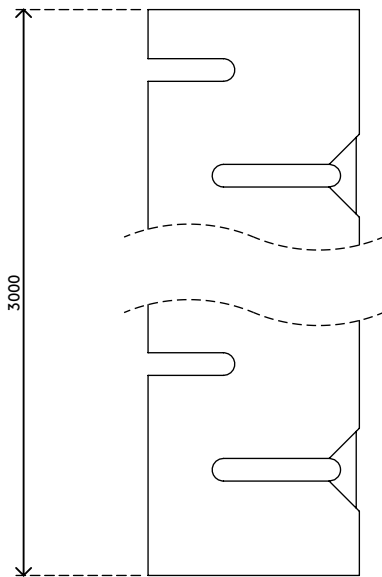

Addit bobina mangiacavo $\varnothing 25$ mm/3 m & utensile inseritore 782

2020/10/07

33.782

 465 x 350 x 50 mm

 1 pcs

 argento

 0,32 kg

 805410337827