

viewmate^x

Garanzia

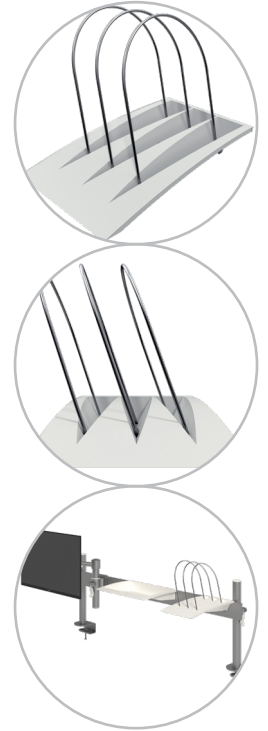
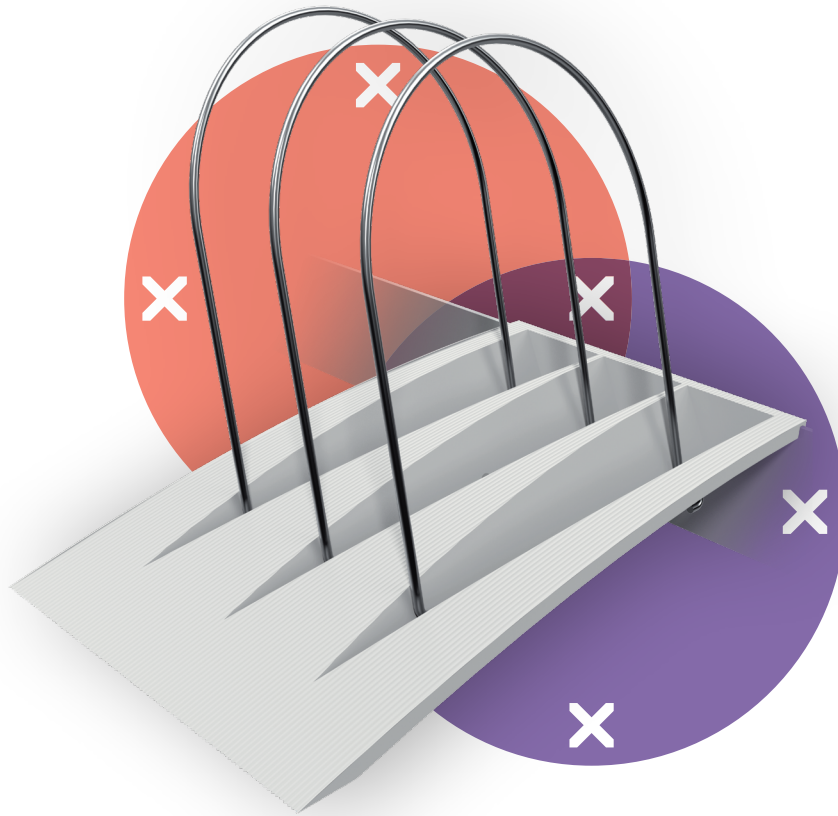

52.180

Viewmate porta raccoglitori - opzione 180

Contiene fino a tre raccoglitori. L'accessorio si fissa semplicemente al binario ed è facile da installare o rimuovere.

- Contiene fino a tre raccoglitori

- Dimensioni (l x p x a): 175 x 322 x 28 mm o 215 mm inclusi i divisori

dataflex

feeling at work

viewmate

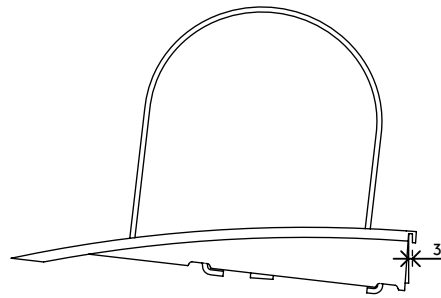
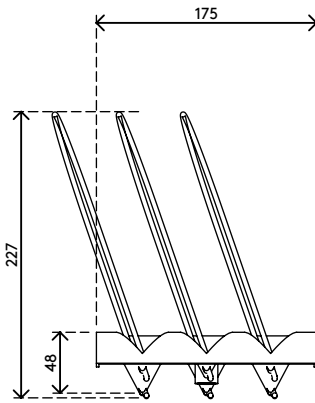
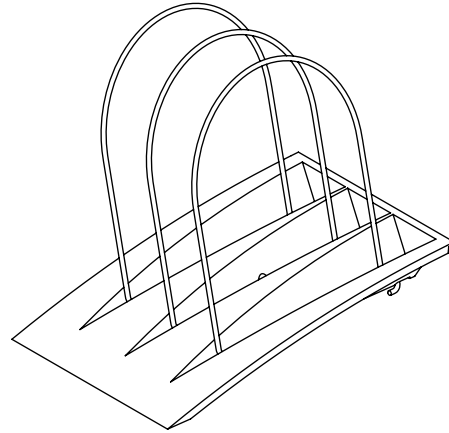
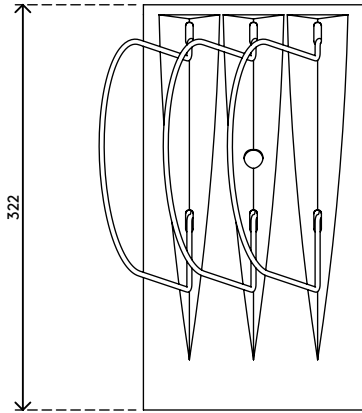

Viewmate porta raccoglitori - opzione 180

2020/10/07

52.180

 265 x 195 x 60 mm

 1 pcs

 bianco

 0,45 kg

 805410521806