

52.572

## Viewmate monitorarm - plafond 572

Gebruik deze plafondbevestiging voor het bevestigen van twee flatscreen-monitors aan een plafond. Wordt gebruikt voor terminals, informatiepunten, verkooppuntsystemen, etc. Bij het installeren kan een van de zeven hoogtevoorinstellingen worden ingesteld. Daarna wordt de hoogte eenvoudig aangepast en bijgesteld met behulp van de klemhendel.

- Bereik statische hoogteverstelling van 600 mm
- Vaste diepte
- Belangrijkste componenten vervaardigd uit staal
- Compatibel met VESA MIS-D 75 x 75/100 x 100 mm
- Monitor: neigen +90°/-90°, zwenken +90°/-90°, roteren 360°
- Draagvermogen van max. 15 kg per monitor
- Voorzien van plafondbevestiging
- Maximale monitorgrootte: hoogte 1104 mm
- Eenvoudig in hoogte verstelbaar met de klemhendel
- Wordt geleverd met alle benodigde bevestigingsmiddelen

# viewmate

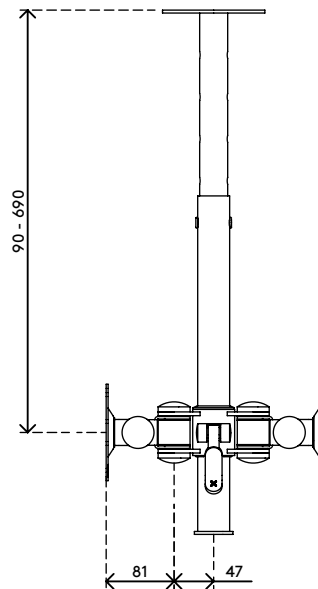
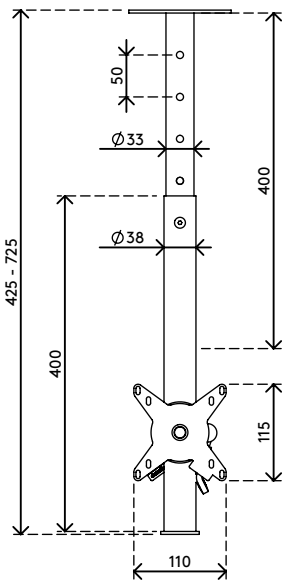
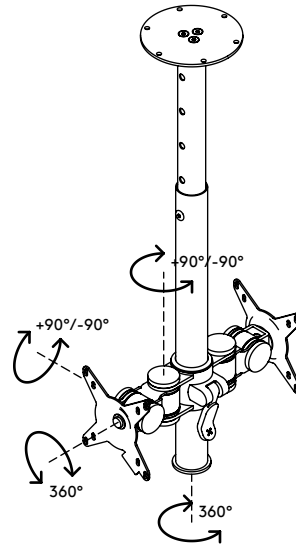
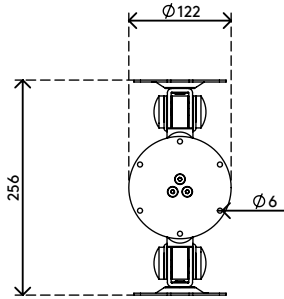

600 mm (23,6")



+90°/-90°

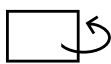

+90°/-90°



360°



1104 mm (43,5")



75 x 75/100 x 100



(2x) 15 kg

## Viewmate monitorarm - plafond 572

2020/05/26

# 52.572

 530 x 185 x 135 mm

 1 pcs

 zilver

 3,6 kg

 805410525729