

# viewmaster

Garanzia

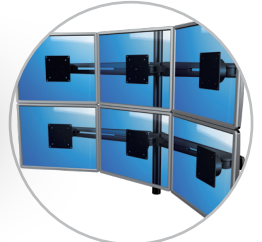

53.633

## Viewmaster sistema multi-monitor - scrivania 633

Il modello permette il fissaggio di un totale di 6 monitor. Come in tutti gli altri sistemi multi-monitor ad ala, ciascun monitor può essere regolato individualmente. La gestione dei cavi nelle ali consente di tenere ordinati tutti i cavi e di ottenere una postazione di lavoro con monitor incurvata e di grande impatto.

- Regolazione graduale dell'altezza
- Per 6 monitor
- Clip per cavi e fascette ferma cavi comprese
- Parti in alluminio pressofuso
- Compatibile con VESA MIS-D 75 x 75/100 x 100 mm
- Monitor: inclinazione +55°/-55°, orientabile +90°/-90°, rotazione 360°
- Capacità peso max. di 12 kg per monitor
- Fissaggio per scrivania non incluso
- Dimensioni massime monitor: larghezza 440 mm - altezza 428 mm
- Grazie all'eccellente stabilità è adatto anche per i touchscreen

**dataflex**

feeling at work

# viewmaster x

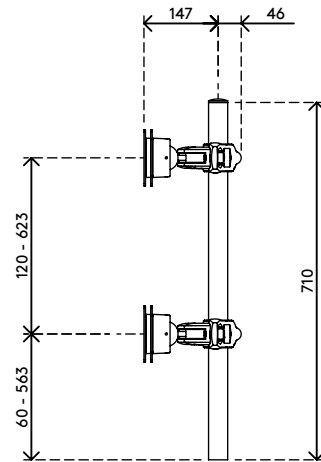
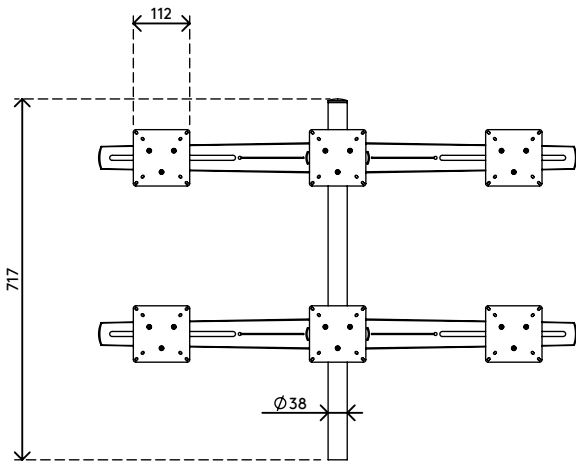
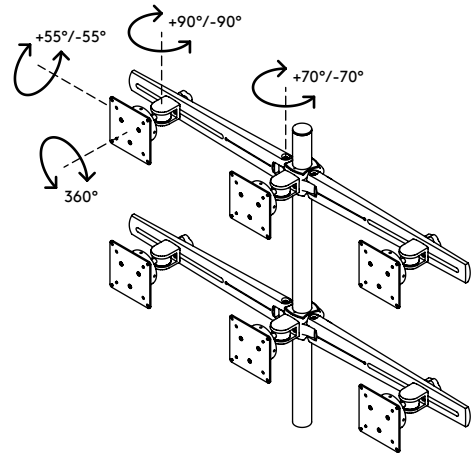
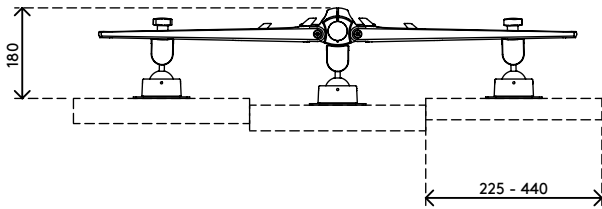

+55°/-55°

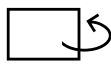

+90°/-90°



360°



440 mm (17,3")



428 mm (16,9")



75 x 75/100 x 100



(6x) 12 kg

Viewmaster sistema multi-monitor - scrivania 633

2020/10/07

# 53.633

 740 x 395 x 120 mm

 1 pcs

 nero

 11,47 kg

 805410536336