

viewmaster^x

Garantie

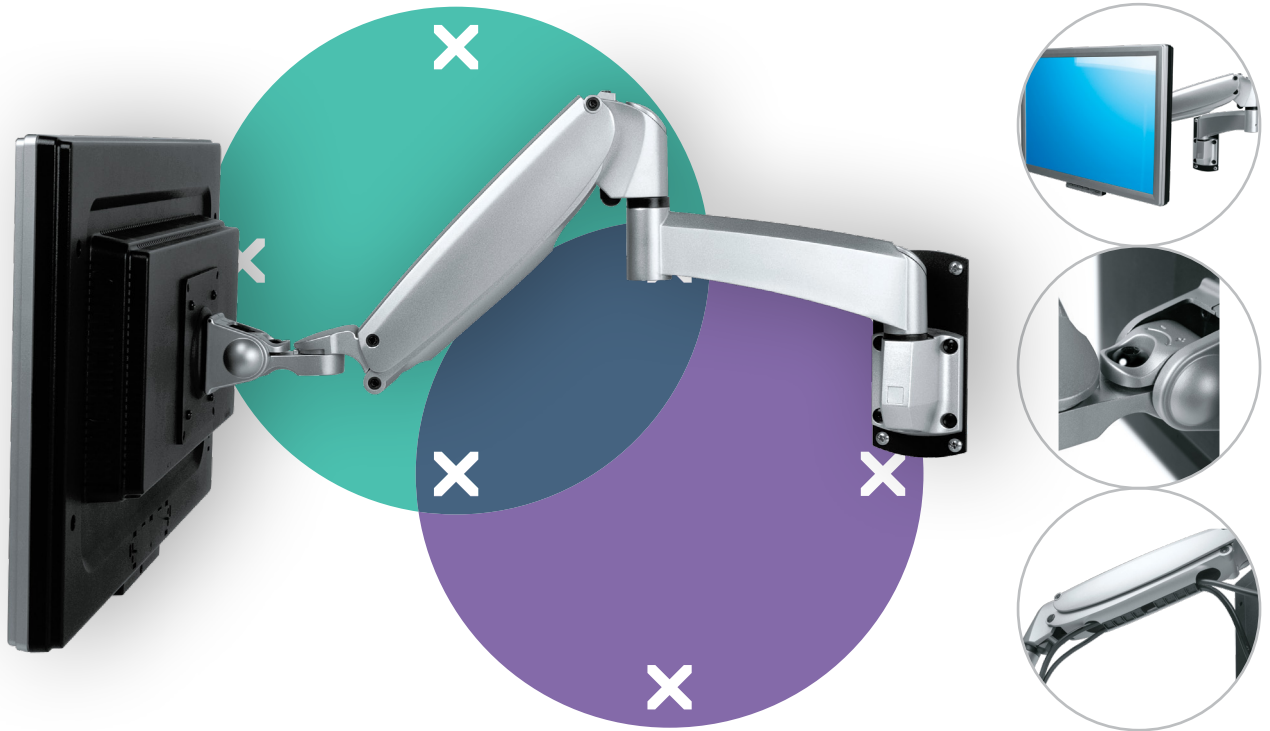

57.252

Viewmaster monitorarm - wand 252

Dynamisch in hoogte en onafhankelijk in diepte verstelbaar zodat elke gebruiker zijn eigen optimale ergonomische positie kan vinden. Een hoogwaardig ontwerp dat de kabels door de armextensions leidt voor een opgeruimde, professionele indruk.

- Bereik dynamische hoogteverstelling van 305 mm
- Onafhankelijke diepteverstelling
- Gedeeltelijk geïntegreerd of verborgen kabelmanagement
- Belangrijkste componenten vervaardigd uit aluminium
- Compatibel met VESA MIS-D 75 x 75/100 x 100 mm
- Monitor: neigen +90°/-90°, zwenken +90°/-90°, roteren +90°/-90°
- Arm: zwenken +90°/-90°
- Draagvermogen van 4,5 - 10 kg per monitor
- Voorzien van wandbevestiging
- Ingebouwde SUSPA®-gasveer
- De vermelde gewichtscapaciteit varieert bij bevestiging van monitoren die dieper zijn dan 25 mm of een VESA-bevestigingspositie hebben die niet in het midden ligt

dataflex^x

feeling at work

viewmaster

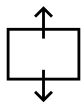
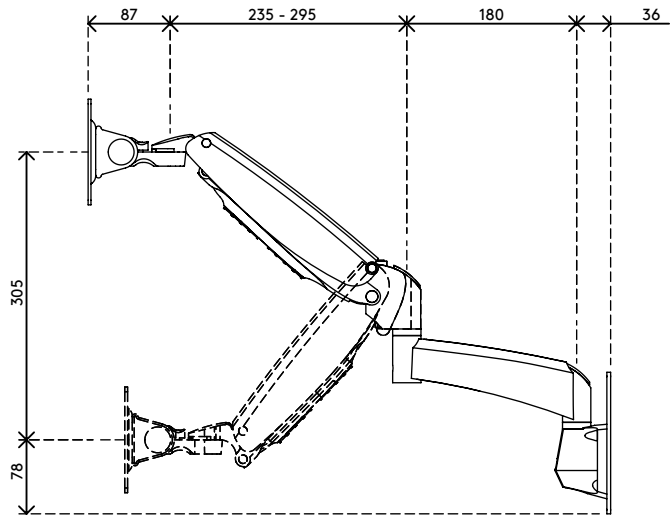
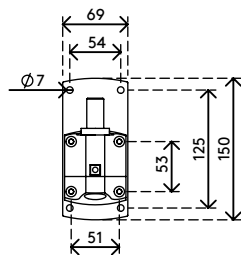
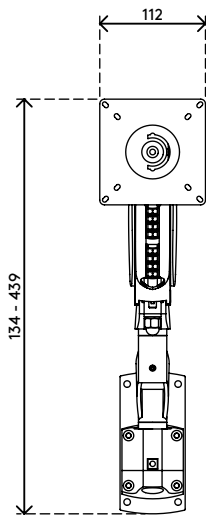
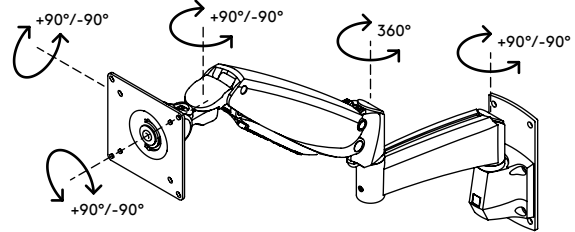
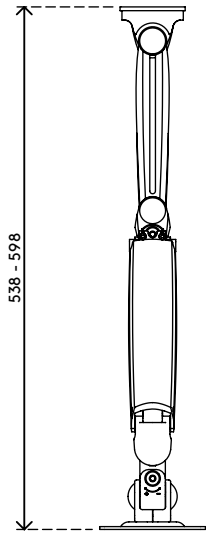

305 mm (12,0")



+90°/-90°

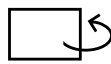

+90°/-90°



+90°/-90°



75 x 75/100 x 100



4,5 - 10 kg

Viewmaster monitorarm - wand 252

2020/05/26

57.252

 490 x 285 x 140 mm

 1 pcs

 zilver

 3,695 kg

 805410572525