

viewlite

FIRA
Part of the Exova Group

Garantie

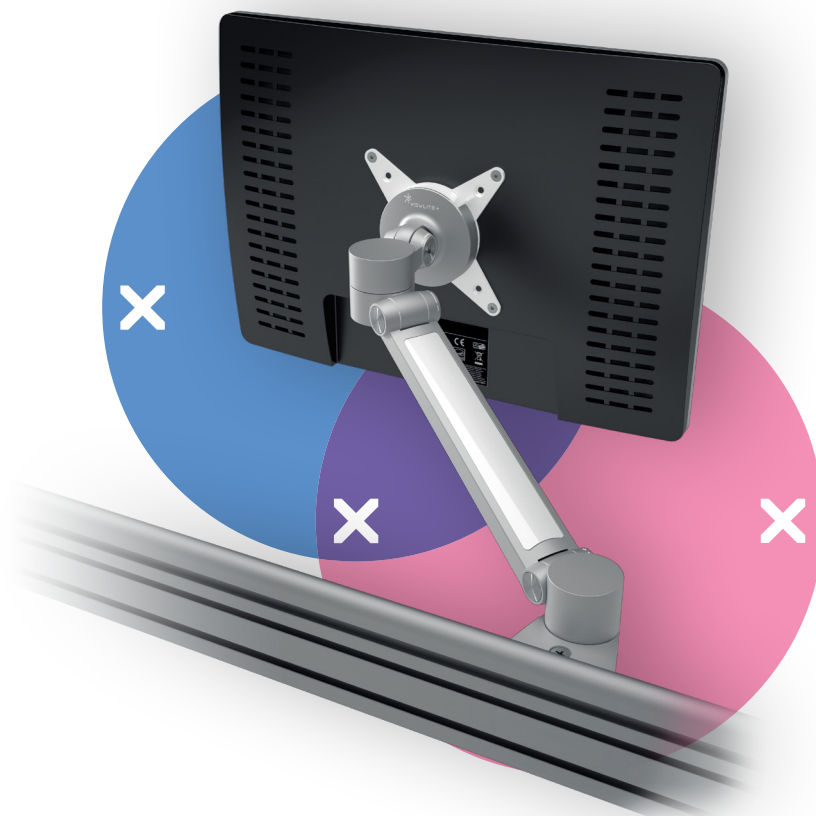

58.512

Viewlite plus monitorarm - rail 512

Maak bureauimte vrij met deze monitorarm die wordt bevestigd op een slatrail/wand of toolbar. Eenvoudig in gebruik en dankzij de zwenkblokkade die de kans op stoten tegen wanden of bureaus vermindert, vrijwel overal te plaatsen. Kabels zitten weggestopt in de aluminium armextensie voor een opgeruimde, professionele indruk.

- Bereik dynamische hoogteverstelling van 240 mm
- Afhankelijke diepteverstelling
- Geïntegreerd kabelmanagement
- Belangrijkste componenten vervaardigd uit aluminium
- 40% van de aluminium componenten zijn al gerecycled
- Compatibel met VESA MIS-D 75 x 75/100 x 100 mm
- Monitor: neigen +90°/-55°, zwenken +90°/-90°, roteren 360°
- Arm: zwenken +90°/-90°
- Draagvermogen van 0 - 7 kg per monitor
- Voorzien van railbevestiging
- Uitgerust met een praktisch quick-releasesysteem, compatibel met VESA
- Gemakkelijk gemonteerd en afgesteld
- Rotatiebegrenzing van de monitor mogelijk
- Zwenkblokkade ingesteld op +90°/-90° (kan worden uitgeschakeld)

dataflex

feeling at work

viewlite

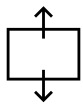
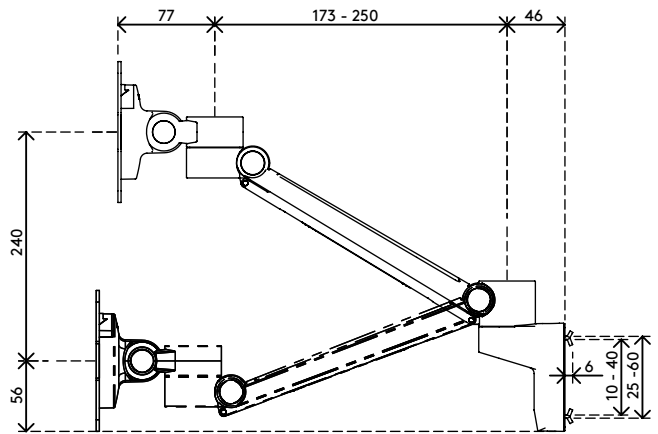
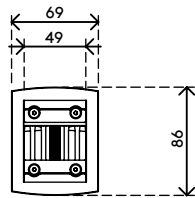
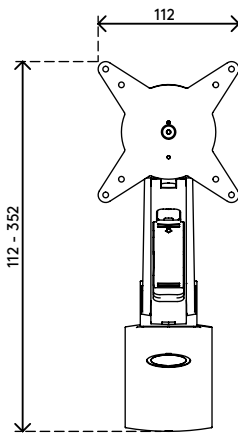
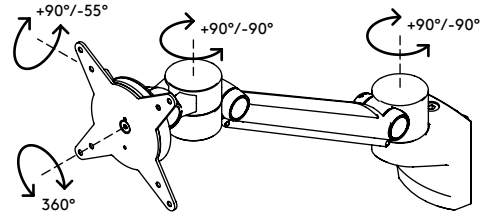
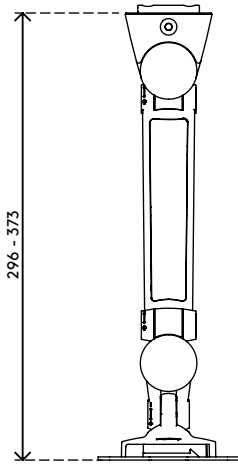

240 mm (9,4")



+90°/-55°



+90°/-90°



360°



75 x 75/100 x 100



0 - 7 kg

Viewlite plus monitorarm - rail 512

2020/05/26

58.512

 477 x 153 x 145 mm

 1 pcs

 silver-wit

 2,151 kg

 805410585129