

96.513

Addit repose-pieds - réglable 513

Avec les jambes posées sur ce repose-pieds, les muscles lombaires sont indirectement soulagés et le dos est maintenu plus confortablement droit en position assise. La hauteur et l'inclinaison de ce repose-pieds se règle sur 4 positions différentes.

- Forme attractive
- Hauteur et inclinaison réglables sur 4 configurations différentes

- Hauteur réglable de 79 à 111 mm
- Dimensions (L x P x H) : 450 x 348 - 371 x 79 - 111 mm
- Réglage d'inclinaison sur 4 positions : 7°, 10°, 14° and 17°

addit

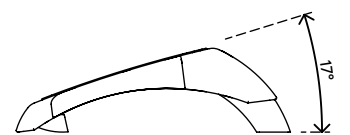
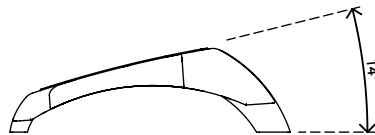
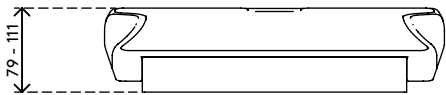
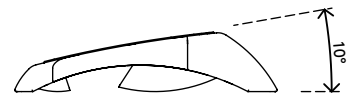
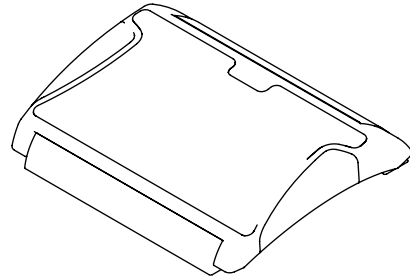
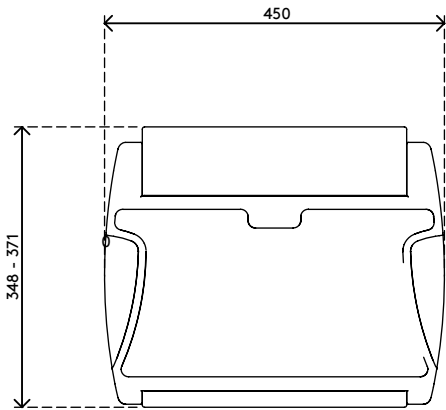

Addit repose-pieds - réglable 513

2021/03/11

96.513

 405 x 350 x 90 mm

 1 pcs

 noir

 1,66 kg

 805410965136